

# USER MANUAL

## NORTH AMERICA, EMEA

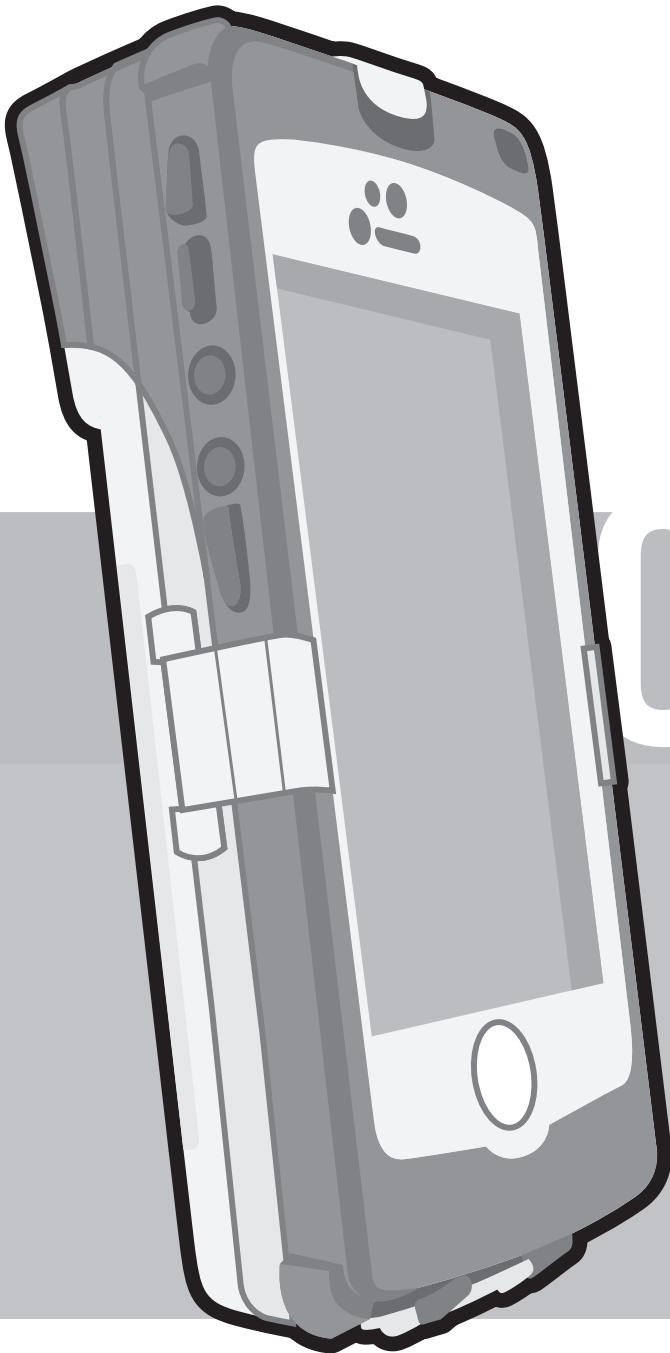

# CR4405

Compatible with Apple® iPhone® 5 and 5s

MANUAL VERSION 03  
RELEASE DATE: JANUARY 2016



[www.codecorp.com](http://www.codecorp.com)



Configuration Guide



[YouTube.com/codecorporation](https://www.youtube.com/codecorporation)

Apple and iPhone are trademarks of Apple Inc., registered in the U.S. and other countries.

 D018433\_03 CR4405 User Manual

**code**  
ADVANCED BARCODE READERS

# Statement of Agency Compliance



The Code Reader™ 4405 (CR4405) has been tested for compliance with FCC regulations and was found to be compliant with all applicable FCC Rules and Regulations.

**IMPORTANT NOTE:** To comply with FCC RF exposure compliance requirements, this device must not be co-located or operate in conjunction with any other antenna or transmitter.



**CAUTION:** Changes or modifications not expressly approved by the party responsible for compliance could void the user's authority to operate the equipment.

The CR4405 has been tested for compliance to CE standards and guidelines and was found to conform to applicable CE standards, specifically the EMC requirements EN 55024, ESD EN 61000-4-2, Radiated RF Immunity EN 61000-4-3, ENV 50204, EFT EN 61000-4-4, Conducted RF Immunity EN 61000-4-6, EN 55022, Class B Radiated Emissions, and Class B Conducted Emissions.



The CR4405 has been tested and certified in compliance with the Technical Regulations Conformity Certification of Specified Radio Equipment (ordinance of MPT N°.37. 1981), Article 2, Paragraph 1, Item 19.

Code voids product warranty if the hard case has been opened or tampered with in any way.

The CR4405 meets all safety and quality standards in accordance to EN 60950-1:2006/A11:2009/A1:2010.

## CR4405 FCC, Industry Canada and ICES Compliance

### FCC:

This device complies with part 15 of the FCC Rules. Operation is subject to the following two conditions: (1) This device may not cause harmful interference, and (2) this device must accept any interference received, including interference that may cause undesired operation.

**NOTE:** This equipment has been tested and found to comply with the limits for a Class B digital device, pursuant to part 15 of the FCC Rules. These limits are designed to provide reasonable protection against harmful interference in a residential installation. This equipment generates, uses and can radiate radio frequency energy and, if not installed and used in accordance with the instructions, may cause harmful interference to radio communications. However, there is no guarantee that interference will not occur in a particular installation.

If this equipment does cause harmful interference to radio or television reception, which can be determined by turning the equipment off and on, the user is encouraged to try to correct the interference by one or more of the following measures:

- Reorient or relocate the receiving antenna.
- Increase the separation between the equipment and receiver.
- Connect the equipment into an outlet on a circuit different from that to which the receiver is connected.
- Consult the dealer or an experienced radio/TV technician for help.

**IMPORTANT!** Any changes or modifications not expressly approved by the party responsible for compliance could void the user's authority to operate this equipment.

**IMPORTANT!** Tous les changements ou modifications pas expressément approuvés par la partie responsable de la conformité ont pu vider l'autorité de l'utilisateur pour actionner cet équipement.

### FCC Radiation Exposure Statement:

This equipment complies with FCC radiation exposure limits set forth for an uncontrolled environment. This equipment should be installed and operated with minimum distance 20cm between the radiator and your body.

### Industry Canada

This device complies with Industry Canada licence-exempt RSS standard(s). Operation is subject to the following two conditions: (1) this device may not cause interference, and (2) this device must accept any interference, including interference that may cause undesired operation of the device.

Le présent appareil est conforme aux CNR d'Industrie Canada applicables aux appareils radio exempts de licence. L'exploitation est autorisée aux deux conditions suivantes : (1) l'appareil ne doit pas produire de brouillage, et (2) l'utilisateur de l'appareil doit accepter tout brouillage radioélectrique subi, même si le brouillage est susceptible d'en compromettre le fonctionnement.

This Class B digital apparatus complies with Canadian ICES-003.

Cet appareil numérique de la classe B est conforme à la norme NMB-003 du Canada.

### Important Note:

#### Radiation Exposure Statement:

This equipment complies with IC radiation exposure limits set forth for an uncontrolled environment. This equipment should be installed and operated with minimum distance 20cm between the radiator and your body.

#### Note Importante: (Pour l'utilisation de dispositifs mobiles)

#### Declaration d'exposition aux radiations:

Cet équipement est conforme aux limites d'exposition aux rayonnements IC établies pour un environnement non contrôlé. Cet équipement doit être installé et utilisé avec un minimum de 20 cm de distance entre la source de rayonnement et votre corps.

# Code Reader™ 4405 User Manual

Copyright © 2016 Code Corporation.

All Rights Reserved.

The software described in this manual may only be used in accordance with the terms of its license agreement.

No part of this publication may be reproduced in any form or by any means without written permission from Code Corporation. This includes electronic or mechanical means such as photocopying or recording in information storage and retrieval systems.

**NO WARRANTY.** This technical documentation is provided AS-IS. Further, the documentation does not represent a commitment on the part of Code Corporation. Code Corporation does not warrant that it is accurate, complete or error free. Any use of the technical documentation is at the risk of the user. Code Corporation reserves the right to make changes in specifications and other information contained in this document without prior notice, and the reader should in all cases consult Code Corporation to determine whether any such changes have been made. Code Corporation shall not be liable for technical or editorial errors or omissions contained herein; nor for incidental or consequential damages resulting from the furnishing, performance, or use of this material. Code Corporation does not assume any product liability arising out of or in connection with the application or use of any product or application described herein.

**NO LICENSE.** No license is granted, either by implication, estoppel, or otherwise under any intellectual property rights of Code Corporation. Any use of hardware, software and/or technology of Code Corporation is governed by its own agreement.

The following are trademarks or registered trademarks of Code Corporation:

CodeXML®, Maker, QuickMaker, CodeXML® Maker, CodeXML® Maker Pro, CodeXML® Router, CodeXML® Client SDK, CodeXML® Filter, HyperPage, CodeTrack, GoCard, GoWeb, ShortCode, GoCode®, Code Router, QuickConnect Code, Rule Runner®, Cortex®, CortexRM, CortexMobile, Code, Code Reader, CortexAG, CortexStudio, CortexTools, Affinity®, CortexDecoder, CortexJPOS, and CortexOPOS.

All other product names mentioned in this manual may be trademarks of their respective companies and are hereby acknowledged.

The software and/or products of Code Corporation include inventions that are patented or that are the subject of patents pending. U.S. Patents: 6997387, 6942152, 7014113, 7070091, 7097099, 7353999, 7519239, 7621453, 8001550, 8011584.

The Code Reader software uses the Mozilla SpiderMonkey JavaScript engine, which is distributed under the terms of the Mozilla Public License Version 1.1. The Code Reader software is based in part on the work of the Independent JPEG Group.

Code, 12393 S. Gateway Park Place, Ste. 600, Draper, Utah 84020

[www.codecorp.com](http://www.codecorp.com)

# Table of Contents

1.0 - Included if Ordered.....	5
2.0 - Battery Installation and Removal .....	6
3.0 - Phone Installation.....	6
4.0 - Charging the CR4405 Sled and Spare Battery .....	7
5.0 - USB Direct Connection to Sled .....	7
6.0 - Powering On the iPhone and Sled Reader.....	7
7.0 - Sled Battery Status Indication.....	8
8.0 - Scanning .....	8
9.0 - Symbologies Defaulted On .....	8
10.0 - Symbologies Defaulted Off.....	8
11.0 - Reading Ranges.....	9
12.0 - CR4405 Sled Reader Configuration .....	9
13.0 - CR4405 Communication Modes.....	10
14.0 - Power Management.....	10
15.0 - Software Development Kit (SDK) .....	10
16.0 - Using CortexMobile® .....	11
17.0 - CortexMobile® Used for Demonstration.....	12
18.0 - Battery Life Management via the SDK.....	12
19.0 - CR4405 Dimensions.....	13
20.0 - Charging Station Dimensions .....	13
21.0 - Sled Reader ID and Firmware Version .....	14
22.0 - Upgrading CR4405 Firmware.....	14
23.0 - CR4405 Maintenance .....	15
24.0 - Warranty .....	15

## 1.0 - Included if Ordered

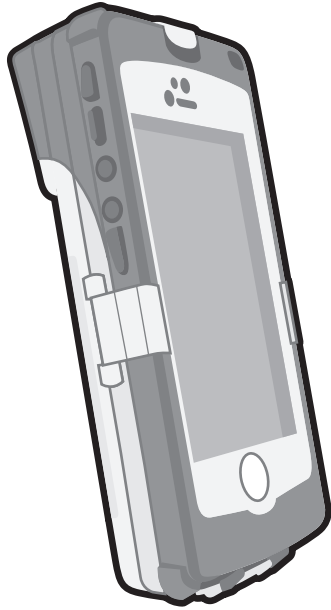

CR4405  
(Model #: CR44X5)



USB 2.0 Cable

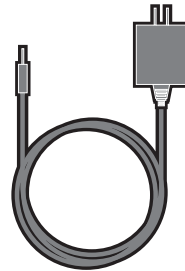

5VDC Power Supply

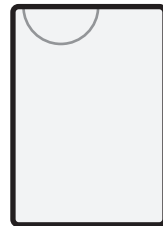

Battery Cartridge

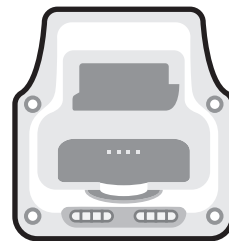

Charging Station

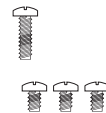

Torx™ T6 Screws

## 2.0 - Battery Installation and Removal

① Insert Battery

② Secure Latch with Torx Screw

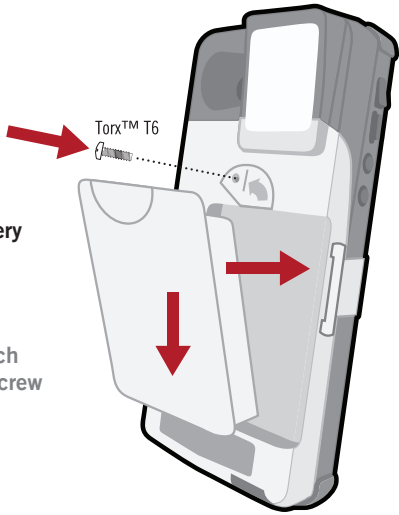

① Remove Torx Screw from Latch

② Turn Latch and Remove Battery

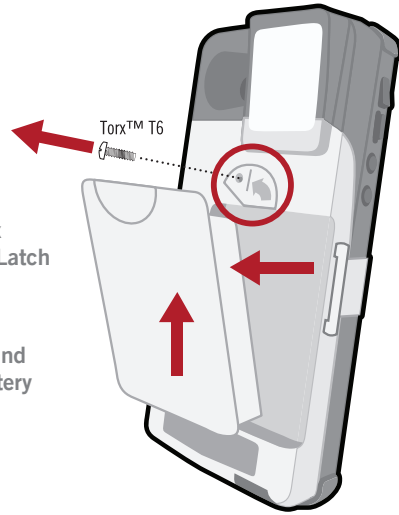

## 3.0 - Phone Installation

①

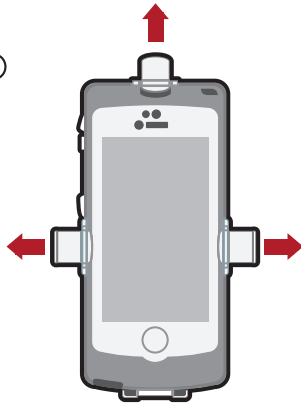

②



③

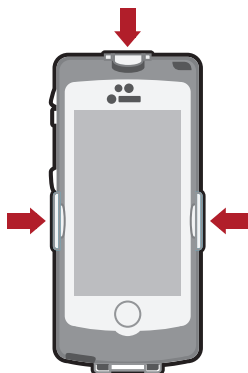

④

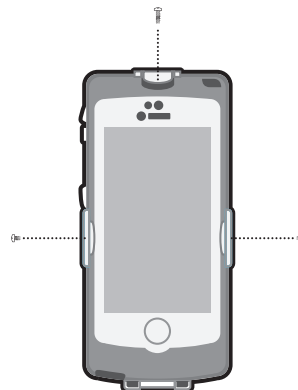

## 4.0 - Charging the CR4405 Sled and Spare Battery

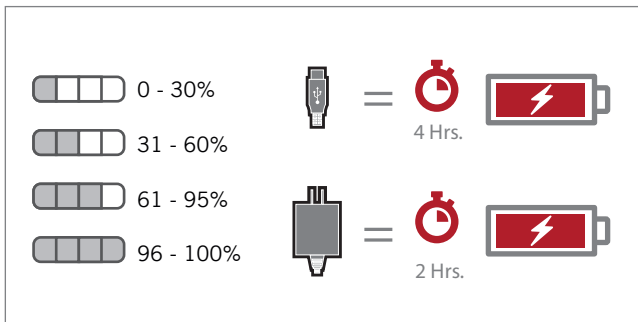
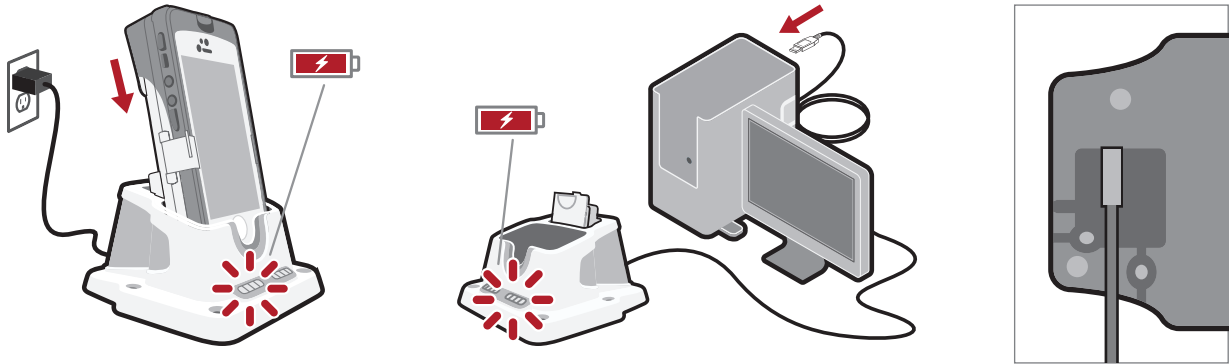

Sled Battery Status While Charging	Sled LED Behavior
0 - 10%	Flashes Red
11 - 30%	Flashes Yellow
31 - 95%	Flashes Green
96 - 100%	Solid Green

## 5.0 - USB Direct Connection to Sled

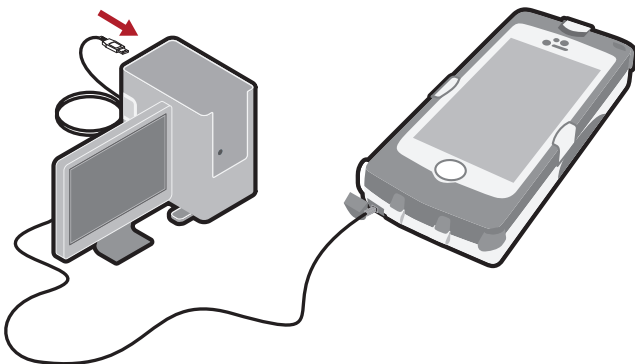

## 6.0 - Powering On the iPhone® and Sled Reader

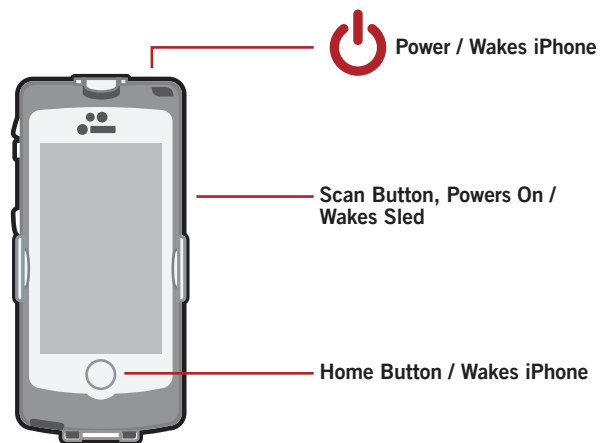

## 7.0 - Sled Battery Status Indication

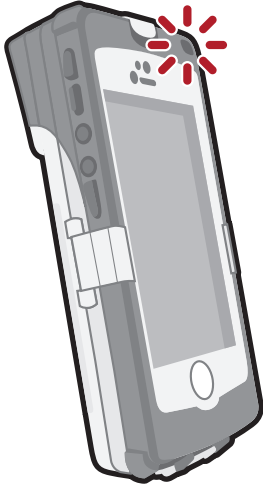

Sled Battery Status While Not Charging	Sled LED Behavior (when scan button is pressed)
100% - 31%	None
30% - 11%	Flashes Yellow 3x
10% - 0%	Flashes Red 3x

## 8.0 - Scanning

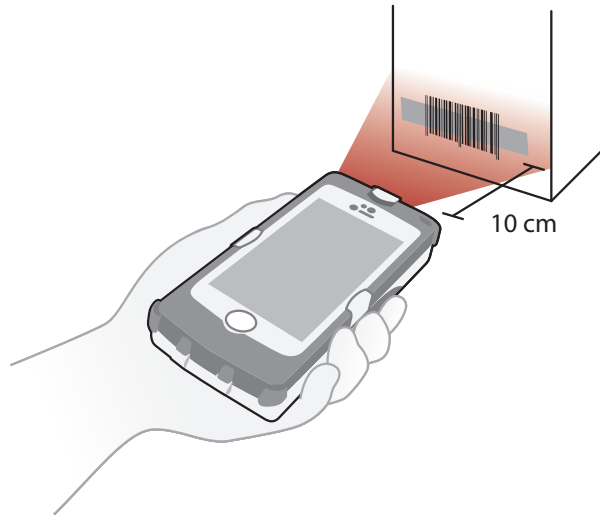

## 9.0 - Symbologies Defaulted On

The following are symbologies that have a default of ON. To turn symbologies on or off, scan the symbology barcodes located in the CR4405 Configuration Guide located on our website at <http://www.codecorp.com>.

Codabar	All GS1 DataBar
Code 39	Interleaved 2 of 5
Code 93	MSI Plessey
Code 128	PDF417
Data Matrix	QR Code
Data Matrix Rectangle	UPC/EAN/JAN

## 10.0 - Symbologies Defaulted Off

The following are symbologies that have a default of OFF. To turn symbologies on or off, scan the symbology barcodes located in the CR4405 Configuration Guide located on our website at <http://www.codecorp.com>.

Codablock F	IATA 2 of 5	Pharmacode
Code 11	Maxicode	Plessey
Code 32	Matrix 2 of 5	Standard 2 of 5
Composite	Micro PDF417	Telepen
Han Xin Code	MSI Plessey	Trioptic
Hong Kong 2 of 5	NEC 2 of 5	Postal Codes



## 11.0 - Reading Ranges

CR4405 Performance		
Test Barcode	Min Inches (mm)	Max Inches (mm)
3 mil Code 39	3.1" (80 mm)	4.0" (102 mm)
7.5 mil Code 39	1.3" (33 mm)	7.2" (182 mm)
10.5 mil GS1 DataBar	0.8" (20 mm)	8.7" (220 mm)
13 mil UPC	1.1" (28 mm)	11.0" (280 mm)
4.2 mil Data Matrix	1.9" (48 mm)	4.3" (110 mm)
5 mil Data Matrix	1.7" (43 mm)	4.5" (115 mm)
6.3 mil Data Matrix	1.3" (33 mm)	5.9" (150 mm)
10 mil Data Matrix	0.8" (20 mm)	7.1" (180 mm)
20.8 mil Data Matrix	1.1" (28 mm)	13.5" (343 mm)

Note: working ranges are a combination of both the wide and high density fields. All samples were high quality barcodes and were read along a physical center line at a 10° angle. Default AGC settings were used. Accuracy= +/- 10%.

## 12.0 - CR4405 Sled Reader Configuration

The CR4405 can be configured for specific tasks, data manipulation, or operational modes by scanning configuration barcodes found in the CR4405 Configuration Guide at <http://www.codecorp.com>.

## 13.0 - CR4405 Communication Modes

The CR4405 has four communication modes, with an associated configuration barcode by the same name in the CR4405 Configuration Guide.

Communication Mode	Description
iPhone Keyboard Communication Mode (default)	This mode allows you to scan data into an iPhone 5/5s application like Notes or a spreadsheet, as if you were manually entering in data (e.g. from the on-screen keyboard).*
iPhone App Communication Mode	This mode allows you to scan data into an iPhone 5/5s application built around the CR44x5 SDK library.
USB Downloader Mode	This mode allows for USB communication with CortexTools® installed on a computer. CortexTools is a utility that is used for firmware upgrades and other diagnostic tasks.
USB Pass-Through Mode	<p>The purpose of this mode is to bypass the sled and allow the iPhone to sync with a PC or Mac for app development, upgrades, or to sync with iTunes via a USB cable connected to a computer.</p> <p>This mode is automatically activated only: 1) When the sled becomes directly connected (i.e. not through a charging station) to a powered USB cable, or 2) When the USB Pass-Through configuration barcode is scanned.</p> <p>In this mode the sled can still scan configuration barcodes, but cannot read and display barcodes. If the sled was in Keyboard Mode or App Mode before becoming directly connected to a powered USB cable, the sled can become enabled for barcode reading by simply unplugging the USB cable causing the sled to revert to the last communication mode set. You can also scan the Keyboard Mode or App Mode configuration barcode if needed.</p>

\* It should be noted that certain third party apps do not allow data to be “tabbed” even though such configurations may be set in the CR4405 reader. For example, some spreadsheet programs require human touch on a new cell in which to enter new data, rather than Prefix-Tab or Suffix-Tab configuration to prompt the cursor to automatically move to a new cell.

## 14.0 - Power Management

Power Management Modes	Description
Sleep Timer (N minutes)	This timer puts the sled to sleep after N minutes of inactivity, thus conserving power. The default value for N is 1 minute.
Enable iPhone Charging via Sled	This power scheme consists of the sled always providing back-up power to the iPhone, until the sled battery level drops to 15% or less (this value can be modified).
Disable iPhone Charging via Sled	This power scheme consists of the sled never providing back-up power to the iPhone, thus preserving its own power for the sole purpose of scanning.
Intelligent Charging	This power scheme is addressed later in this document.

## 15.0 - Software Development Kit (SDK)

Code developed an SDK for the CR4405 that contains the tools necessary to assist in the development of an iPhone software application that can communicate with the sled. Such an app can provide benefits like battery status indication and advanced power management. The SDK contains documentation, a library and source code for the CortexMobile® demonstration app. The source code provides examples on how to access the relevant library elements to communicate with the CR4405 firmware. The SDK is available on Code's website.

## 16.0 - Using CortexMobile®

CortexMobile® is an iPhone 5/5s software application developed by Code to demonstrate the capabilities of the CR4405. This software app can serve as a reference for programmers who use Code's SDK to build other apps which can be downloaded to the iPhone from the App Store. The sled must be in iPhone App Communication Mode to run Code SDK-based applications.

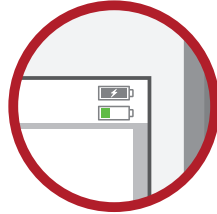

The main application screen contains two battery icons, the first indicates your iPhone battery status, the second indicates the sled battery status.





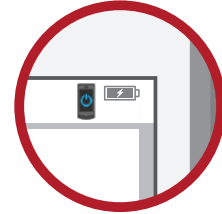

If the 'not connected icon' appears in the place of the sled battery status icon, ensure that the sled is in iPhone App Communication Mode by scanning the related barcode located in the configuration guide. Note that the "soft" scan button will be grayed out until the correct communication mode is set.



If the 'power icon' appears in the place of the sled battery status icon, the sled is in sleep mode and must be woken before scanning can continue. A message may also appear on the screen prompting you to press the scan button located on the side of the CR4405. After doing so, the sled should be ready for scanning.

CortexMobile® Button Descriptions

Button	Description
 Scan	Allows you to scan barcodes either with the use of the on-screen "soft" scan button or the scan button located on the side of the CR4405. Scanned barcode data will appear on the main screen of the app.
 Info	Displays a screen containing general information about the reader, such as status, version, firmware, etc.
 Advanced	Directs you to the: <ul style="list-style-type: none"> <li>• "Terminal" screen where commands can be sent directly to the sled. Responses will be displayed on the main screen below the input field. This feature is particularly beneficial to advanced users. Please contact Code for additional information.</li> <li>• "Image Upload" screen where actual images of the barcode can be uploaded or forwarded in a message.</li> <li>• "Sled Firmware Upgrade" screen where various firmware versions for the sled can be wirelessly downloaded and installed on the sled.</li> </ul>
 More	Directs you to the: <ul style="list-style-type: none"> <li>• "App Configuration" screen which allows various settings as desired.</li> <li>• "Help" screen which allows you to reference the various features of CortexMobile®.</li> </ul>

## 17.0 - CortexMobile® Used for Demonstration

A default time of 1 minute is set for sled inactivity before going to sleep. Activating CortexMobile® disables sleep. The next time the sled reboots, the sleep timer setting reverts to its default value.

## 18.0 - Battery Life Management via the SDK









Power consumption generally depends on scanner and iPhone usage. CortexMobile™ can demonstrate the SDK's ability to implement a sophisticated power management scheme called Intelligent Charging that allows the sled battery to provide power necessary for scanning and back-up power to a connected iPhone. The sled can do this by monitoring the battery levels of both itself and the iPhone.

**NOTE:** Although Intelligent Charging is a default setting on the reader, it can only be implemented if the sled is in iPhone App Communication Mode and running an SDK-based app. Otherwise the sled will always charge the iPhone until the sled's battery level drops to 15% or less.

**NOTE:** Intelligent Charging can be deactivated by scanning the configuration barcode for one of the other two charge modes available (iPhone Always Charging via Sled or iPhone Never Charging via Sled).

To accomplish Intelligent Charging, CR4405 firmware settings have been created to define key thresholds, which are:

- "Sled Battery Reserve Level." This default sled battery threshold is 40%, which means that 40% of the CR4405 battery charge (if available) will be allocated to scanning for approximately 12 hours, assuming 100 scans per hour.
- "Sled Battery Critical Level." This default sled battery threshold is 15%, below which the CR4405 will no longer provide back-up power to the iPhone, and will reserve power only for scanning and sled management.
- "iPhone Battery Critical Level." This default iPhone battery threshold is 25%, below which the CR4405 will primarily charge the iPhone depending on the sled battery level.

If...		Then...
iPhone Battery Status	Sled Battery Status	Sled
Any level	Greater than 	WILL charge the iPhone
Greater than 	 to 	WILL NOT charge the iPhone
Less than 	 to 	WILL charge the iPhone
Any level	Less than 	WILL NOT charge the iPhone

## 19.0 - CR4405 Dimensions

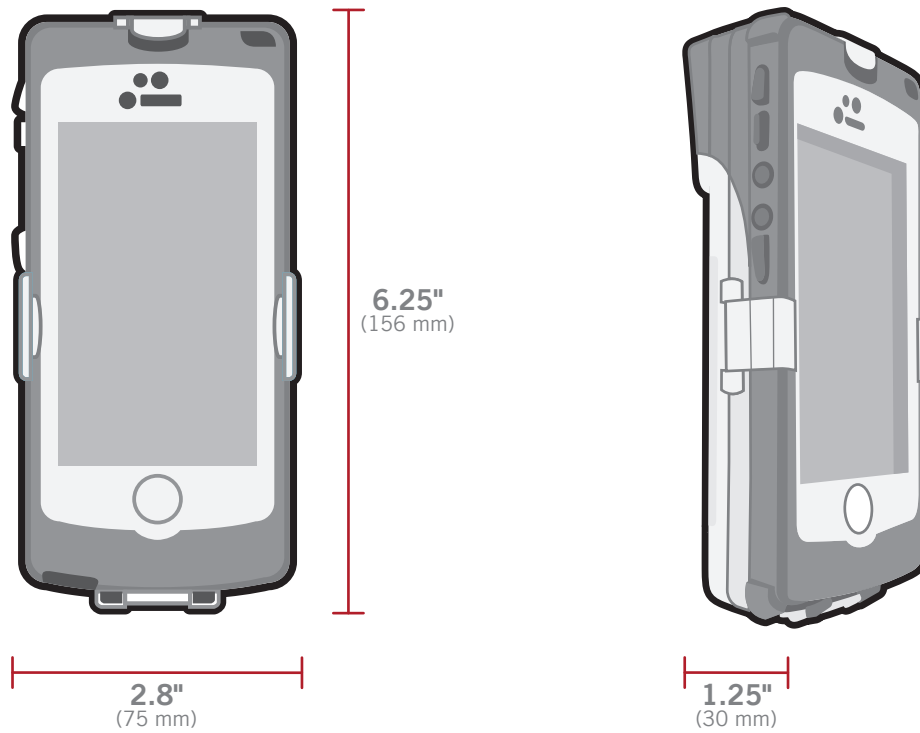

## 20.0 - Charging Station Dimensions

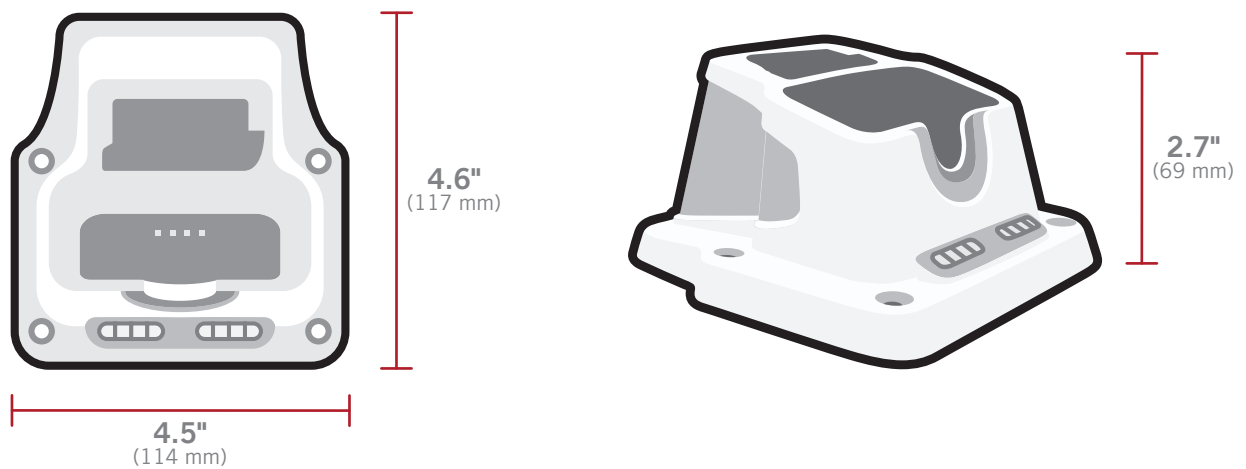

## 21.0 - Reader ID and Firmware Version

To find out the Reader ID and Firmware version, open a text editor program (i.e., Notepad, Microsoft Word, etc.) and read the Reader ID and Firmware configuration barcode.

### Reader ID and Firmware



M10157\_01

A text string indicating the firmware version and CR4405 ID number will be displayed.

example: Xap/i06760456none0020094903A0600000070007001600620002 0 cd(13.2.18) (see below):

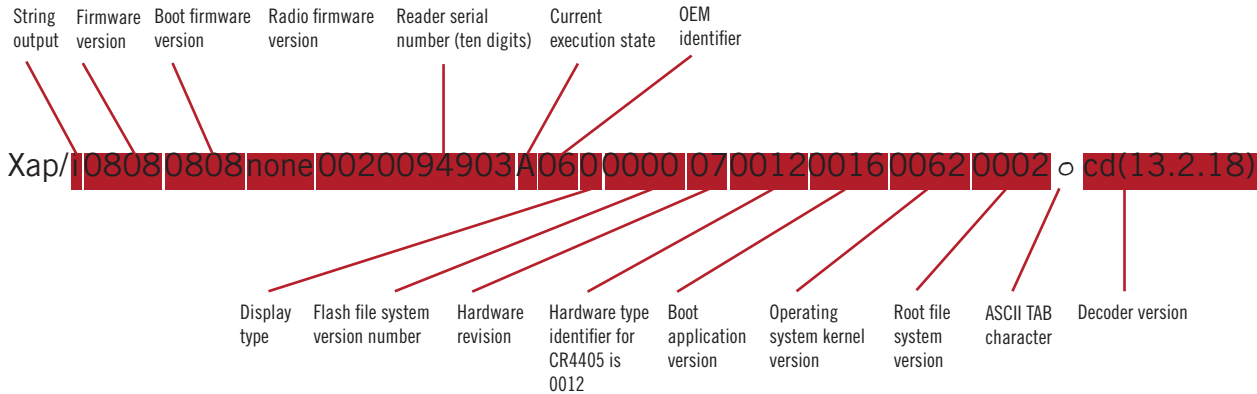

Note: Code will periodically release new firmware for CR4405 readers. For information on latest firmware visit our website at [www.codecorp.com/codesupport.php](http://www.codecorp.com/codesupport.php).

## 22.0 - Upgrading the CR4405 Firmware

The CR4405 sled's firmware can be updated by downloading firmware to a PC from <http://www.codecorp.com/downloads.php>. The firmware can then be loaded on the sled via the provided USB cable connected directly to the PC running CortexTools. The sled must be in USB Downloader Mode. During the firmware upgrade the sled's upper right LED will flash yellow. When finished, be sure to unplug the USB cable and return the sled to the communication mode set prior to putting it in USB Downloader Mode.

## 23.0 - CR4405 Maintenance

The CR4405 needs only minimum maintenance to operate. The tips below for maintenance suggestions.

### Enhancing the CR4405's Touchscreen Capacitive Cover

The CR4405 contains a transparent capacitive cover that helps protect the iPhone and seals out moisture and debris. The cover is resistant to abrasion, corrosion, thermal exposure and impact. A scratch resistant material is also applied to both sides of the cover during the manufacturing process. The cover is tightly stretched and attached to the sled case to provide ruggedness and trouble-free touch response from the iPhone's screen. For best operation, caution should be taken to ensure that the iPhone screen is free from dirt, oils, and additional protective covers (e.g. mylar stickers).

### Cleaning the CR4405

The CR4405 window should be clean to allow the best performance of the device. The window is the clear plastic piece inside the head of the reader. Avoid touching the window. Your CR4405 uses CMOS technology that is much like a digital camera. A dirty window may stop the CR4405 from reading barcodes.

If the window becomes dirty, clean it with a soft, non-abrasive cloth or a facial tissue (no lotions or additives) that has been moistened with water. A mild detergent may be used to clean the window, but the window should be wiped with a water moistened cloth or tissue after using the detergent.

### Technical Support and Returns

To modify any default settings, download the CR4405 Configuration Guide at [www.codecorp.com/files.php](http://www.codecorp.com/files.php) and scan the appropriate barcode. For user specific configurations, visit [www.codecorp.com/codesupport.php](http://www.codecorp.com/codesupport.php).

For all returns Code will issue an RMA number which must be placed on the packing slip when the reader is returned. Visit [www.codecorp.com/codesupport.php](http://www.codecorp.com/codesupport.php) for more information.

## 24.0 - Warranty\*

The CR4405, Charging Stations and Batteries carry a one year limited warranty as described herein.

### Limited Warranty

Code warrants each Code product against defects in materials and workmanship under normal use for the Warranty Coverage Term applicable to the product as described at [www.codecorp.com/legal/warranty/term.php](http://www.codecorp.com/legal/warranty/term.php). If a hardware defect arises and a valid warranty claim is received by Code during the Warranty Coverage Term, Code will either: i) repair a hardware defect at no charge, using new parts or parts equivalent to new in performance and reliability; ii) replace the Code product with a product that is new or refurbished product with equivalent functionality and performance, which may include replacing a product that is no longer available with a newer model product; or ii) in the case of failure with any software, including embedded software included in any Code product, provide a patch, update, or other work around. All replaced products become the property of Code. All warranty claims must be made using Code's RMA process.

### Exclusions

This warranty does not apply to: i) cosmetic damage, including but not limited to scratches, dents, and broken plastic; ii) damage resulting from use with non-Code products or peripherals, including batteries, power supplies, cables, and docking station/cradles; iii) damage resulting from accident, abuse, misuse, flood, fire or other external causes, including damage caused by unusual physical or electrical stress, immersion in fluids or exposure to cleaning products not approved by Code, puncture, crushing, and incorrect voltage or polarity; iv) damage resulting from services performed by anyone other than a Code authorized repair facility; v) any product that has been modified or altered; vi) any product on which the Code serial number has been removed or defaced. If a Code Product is returned under a warranty claim and Code determines, in Code's sole discretion, that the warranty remedies do not apply, Code will contact Customer to arrange either: i) repair or replace the Product; or ii) return the Product to Customer, in each case at Customer's expense.

\*Warranty periods are North America specific.

## 24.0 - Warranty\*

### Non Warranty Repairs

Code warrants its repair/replacement services for ninety (90) days from the date of shipment of the repaired/replacement product to the Customer. This warranty applies to repairs and replacements for: i) damage excluded from the limited warranty described above; and ii) Code Products on which the limited warranty described above has expired (or will expire within such ninety (90) day warranty period). For repaired product this warranty covers only the parts that were replaced during the repair and the labor associated with such parts.

### Non Extension of Term of Coverage

Product that is repaired or replaced, or for which a software patch, update, or other work around is provided, assumes the remaining warranty of the original Code Product and does not extend the duration of the original warranty period.

### Software and Data

Code is not responsible for backing up or restoring any of software, data, or configuration settings, or reinstalling any of the foregoing on products repaired or replaced under this limited warranty.

### Shipping and Turn Around Time

The estimated RMA turn-around time from receipt at Code's facility to shipment of the repaired or replaced product to Customer is ten (10) business days. An expedited turn-around time may apply to products covered under certain CodeOne Service Plans. Customer is responsible for shipping and insurance charges for shipping Code Product to Code's designated RMA facility and repaired or replaced product is returned with shipping and insurance paid by Code. Customer is responsible for all applicable taxes, duties, and similar charges.

### Transfer

If a customer sells a covered Code Product during the Warranty Coverage Term, then that coverage may be transferred to the new owner by written notification from the original owner to Code Corporation at:

CodeOne Service Center  
12393 South Gateway Park Place, Suite 600  
Draper, UT 84020  
Limitation on Liability

Code's performance as described herein shall be Code's entire liability, and the Customer's sole remedy, resulting from any defective Code product. Any claim that Code has failed to perform its warranty obligations as described herein must be made within six (6) months of the alleged failure. Code's maximum liability related to its performance, or failure to perform, as described herein shall be limited to the amount paid by Customer for the Code product that is subject to the claim. In no event will either party be liable for any lost profits, lost savings, incidental damage, or other economic consequential damages. This is true even if the other party is advised of the possibility of such damages.

EXCEPT AS MAY BE OTHERWISE PROVIDED BY APPLICABLE LAW, THE LIMITED WARRANTIES DESCRIBE HEREIN REPRESENT THE ONLY WARRANTIES CODE MAKES WITH RESPECT TO ANY PRODUCT. CODE DISCLAIMS ALL OTHER WARRANTIES, WHETHER EXPRESSED OR IMPLIED, ORAL OR WRITTEN, INCLUDING WITHOUT LIMITATION IMPLIED WARRANTIES OF MERCHANTABILITY, FITNESS FOR A PARTICULAR PURPOSE AND NON-INFRINGEMENT.

THE REMEDIES DESCRIBED HEREIN REPRESENT CUSTOMER'S EXCLUSIVE REMEDY, AND CODE'S ENTIRE RESPONSIBILITY, RESULTING FROM ANY DEFECTIVE CODE PRODUCT.

CODE SHALL NOT BE LIABLE TO CUSTOMER (OR TO ANY PERSON OR ENTITY CLAIMING THROUGH CUSTOMER) FOR LOST PROFITS, LOSS OF DATA, DAMAGE TO ANY EQUIPMENT WITH WHICH THE CODE PRODUCT INTERFACES (INCLUDING ANY MOBILE TELEPHONE, PDA, OR OTHER COMPUTING DEVICES), OR FOR ANY SPECIAL, INCIDENTAL, INDIRECT, CONSEQUENTIAL OR EXEMPLARY DAMAGES ARISING OUT OF OR IN ANY MANNER CONNECTED WITH THE PRODUCT, REGARDLESS OF THE FORM OF ACTION AND WHETHER OR NOT CODE HAS BEEN INFORMED OF, OR OTHERWISE MIGHT HAVE ANTICIPATED, THE POSSIBILITY OF SUCH DAMAGES.

\*Warranty periods are North America specific.